

FAQ

HDMI connected, but no SDI output?

When two HDMI devices are connected together, the EDID communication protocol automatically determines the highest resolution both devices support and configures the HDMI link to that resolution. CHD 1412 supports video formats up to 2160p60. If the HDMI Input is 2160p60, the SDI Output per default will be 12G SDI.

If 3G, 1.5G or 270M SDI output is needed, the HDMI source device should be manually set to output the desired video resolution.

The CHD 1412 has **no internal scaler**, but it is possible to force the desired video format with LynxCentraal or yelloGUI. This is done by ignoring the formats reported via EDID and selecting an appropriate format via LynxCentraal or yelloGU. As a result the recognized HDMI resolution is changed and the **output might either be cropped or boxed**. For examples, where HDMI formats result in either cropping, boxing, or any combination of both, please refer to the datasheet.

HDMI LED off, but connected?

The HDMI content may have HDCP copy protection, in which case the HDMI present LED will be OFF and the module will block the conversion and provide a black SDI output.

Note: Consumer devices usually include HDCP copy protection even if the source media is not copy protected. Please verify the operation of the yellobrik module on a HDMI source which is known not to have HDCP copy protection (e.g. most HDMI cameras) before contacting technical support.

Compatible Formats?

Any HDMI input can have a wide range of formats. These vary not only in resolution, but also aspect ratio. We compiled a list of expected, compatible formats. It can be found on the product page.

Note: We are continuously working on improving our products, this list might expand in the future.



CHD 1412
Product Page



CHD1412_R01

yellobrik®

Technical Specifications

HDMI Input	Type A 2.0b connector for up to 2160p60 Up to 8 channels embedded audio in HDMI is passed transparently or replaced with external analog audio input
Reference Input	SDTV: Analog 525 or 625 bi-level sync, black burst or colorbars HDTV, 3G, 12G: All tri-level sync standards (exceptions 1080p 50/59.94/60Hz) Cross lock compatible SMPTE 274M, SMPTE 296M - 75 Ohm BNC connector
Frame Synchronizer	Functional if valid reference is detected, otherwise operates in free run (asynchronous) mode. External audio and HDMI input are frequency locked to external reference, fully cross lock compatible across standards. One frame adjustable delay (in line and pixel increments) using LynxCentraal or yelloGUI
SDI Outputs	2 x SDI video, 75 Ohm BNC (both have the same signal - NOT dual link) SMPTE 259M, SMPTE 292M, SMPTE 424M, SMPTE 2081-1, SMPTE 2082-1 Electrical Return Loss: to 1.5GHz to 3GHz to 6GHz to 12GHz >15dB >10dB >7dB >4dB
Fiber Output	Optional plug in SFP for optical SDI output (see fiber options table) SMPTE 297 - 2006
Audio Inputs	Left and right analog audio using 3.5mm jack plugs 10k Ohm differential balanced input mode with 24,22,20,18,15,12 dBu and User definable full scale level(selectable) Unbalanced mode with (line level) at -10 dBV (3.5mm Jack Plug to RCA connection adapters supplied) Selectable AES channel for audio embedding (1 through 8) (Overwrites any HDMI embedded audio present in selected channel) Frequency response: <+/- 0.1dB 20Hz to 20KHz 48kHz A/D sample rate (frequency locked to SDI output)
Power	+12V DC @ 10.0W (excl. SFP) nominal - (supports 10 - 14V DC input range)

LYNXTechnik AG | www.lynx-technik.com

yellobrik®

Quick Reference

CHD 1412

4K HDMI® to 12G-SDI Converter + Frame Synchronizer

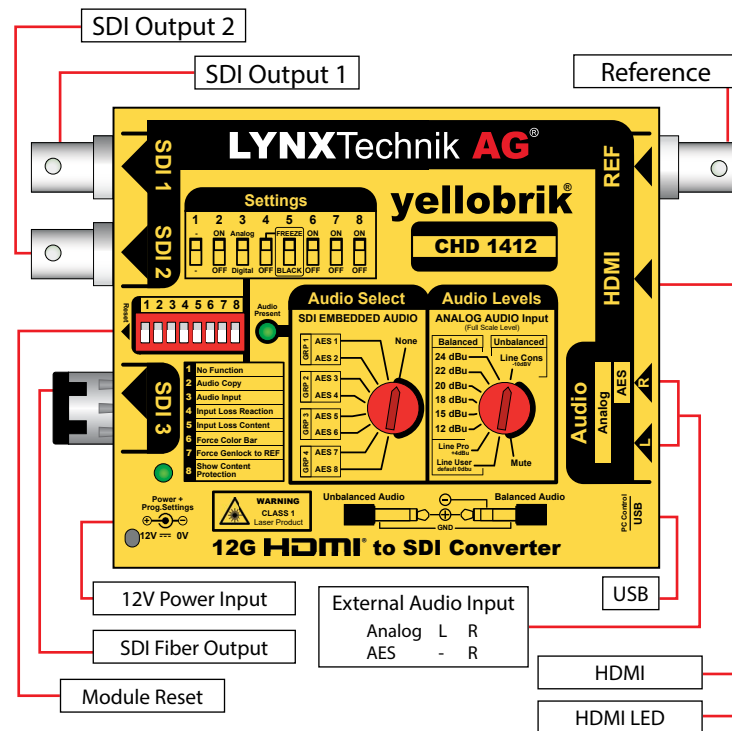

WARNING
CLASS 1M LASER PRODUCT



Laser Radiation
Do not look directly into emitter
with optical instruments

Connections

All connections are clearly indicated on the module. The fiber SDI output is optional and can be added at any time if needed using the socket provided (plug in SFP module).



Operation

The CHD 1412 module is a powerful HDMI to SDI conversion device. It auto-detects the connected HDMI standard and, if valid, converts it to SDI. The HDMI is converted to an SDI signal in its native SDI resolution (no scaling). Any audio present on the HDMI signal will be automatically embedded into the SDI outputs.

HDCP Copy Protection

The CHD 1412 **WILL NOT** convert any HDCP encrypted content. If a HDMI source is connected and the "HDMI present" is off then the HDMI content is most likely protected with HDCP.

Audio

Up to 8 HDMI contained audio channels are present on the HDMI input and automatically embedded into the SDI outputs (AES channels 1, 2, 3, 4).

The HDMI audio is not modified or decoded. If encoded audio is present such as Dolby Digital then this encoded stream will be embedded (transparently) into the SDI output.

Alternatively it is possible to embed external audio sources. These are analog audio (various balanced and unbalanced selections possible via rotary dial and remote software) and AES audio.

Note: One AES channel = two channels of audio.



Fiber Output (optional)

An SDI fiber output is provided via a removable SFP fiber stick. This can be a standard SDI Transmitter (1310nm) or a CWDM version (18 wavelength choices). Please contact LYNX Technik for more details on the fiber options compatible with this module.







Module LEDs

The module has several LEDs included to indicate status:

HDMI Present LED

-  Green Valid HDMI signal connected
-  Off Non valid HDMI signal, HDCP error, or signal missing

Power / Prog Setting LED

-  Green Power OK and no internal programmed settings are present
-  Yellow Power OK and some programmed settings are active*
-  Yellow (blinking) "Locate" functionality enabled via control software to identify physical module
-  Red Power OK and physical settings are overwritten by software settings.
-  Red (blinking) Hardware malfunction (Fan Error, Overheating, etc.)
-  Off Power not present

* Some additional internal settings have been made using control software and the LED indicates this by turning yellow. The module can be reset to factory defaults by using the GUI or reset switch (recessed under a hole on the side of the module). When reset the LED will change back to green.

USB Port / Firmware Updates / Control Software

The USB interface of the module is used for remote control and firmware updates. To update a yellobrik, power it on and connect it to a PC or Mac running either LYNX control software (yelloGUI or LynxCentraal) with the provided USB cable. If a new firmware is available the control software will notify you.

For updates through LynxCentraal, just click the "Update" button on the left side. From there you can pick and choose which device to update.

Firmware updates are always free of charge.



yelloGUI



LYNX | Centraal™

Fiber I/O Options

The module can accommodate several fiber options, which are detailed below. These are SFP sub modules and plug into the side of the module. We can also supply CWDM versions in 18 different wavelengths if required (contact LYNX Technik for more details).

SDI Fiber Transmitter Options		
Model	Description	Power
OH-TX-12G-LC	SFP Fiber TX - Singlemode - LC connector - 10km*	0.5dBm
OH-TX-4-12G-LC	SFP Fiber TX - Singlemode - LC, ST or SC conn. - 40km*	3dBm
OH-TX-12-XXXX-LC	CWDM SFP Fiber TX - Singlemode LC Conn. - 10km* XXXX=Wavelength. 18 according to ITU T G692.2 1270nm through 1610nm	3dBm

* Distances are an approximation and can vary depending on individual setups.

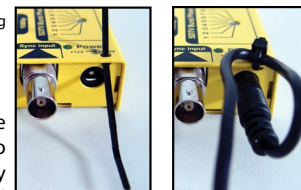

Power Lead Strain Relief

The module has a small hole in the case located above the power connection. To prevent the power lead being accidentally pulled out, use the supplied tie-wrap and secure the lead as shown.

Mounting Solutions

The optional RFR 1001 mounting bracket can be used to permanently mount the module on any surface or on 19" rack rails.

The optional RFR 1200 rack mount can be used to permanently mount up to 14 yellobrik modules. In addition, the RFR 1200 can provide full power redundancy for all mounted yellobriks.

