

Serial and GPI Fiber Transceiver

- Extend serial and GPI connections up to 10km
- Supports serial RS232 or RS422 or RS485
- 2 x GPI connections
- Singlemode fiber 1310nm up to 10km (6.2 miles)
- Multimode fiber 850nm up to 550m (1,804 feet)
- LC/PC duplex fiber connections
- Switchable RX/TX crossover
- Automatic or manual data direction
- Switchable end of line termination
- 'Plug and Play' - No PC software drivers needed
- Supports all serial protocols (standard or proprietary)

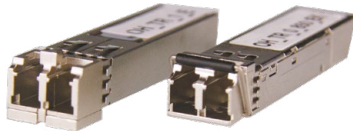

Singlemode SFP Multimode SFP

Using the same basic module we provide two versions suitable for singlemode or multimode fiber. Each version has a different SFP installed.

The ODT 1510 is a multi-function module which (when used with another ODT 1510 in the remote location) will extend the reach of serial RS232, RS422 or RS485 as well as two GPI (general purpose I/O) up to 10km (6.2 miles) over fiber.

A single RJ45 electrical serial connection can be configured for RS232, RS422 or RS485 serial standards. A separate RJ45 connector is provided for two electrical GPI inputs and outputs. Serial communications and GPI are transmitted and extended over the same fiber link.

The ODT 1510 is completely agnostic to the serial protocol used, and supports all standard protocols and proprietary protocols at data rates from 300 to 460k Baud (*auto sensing and auto adjusting*).

The integrated dip switch provides precise control over the serial mode of operation with selections for the *serial standard, serial termination, RX/TX crossover and RS422/485 data direction (automatic or manual)*. Data activity LEDs are provided for the serial port and the GPI port under the respective RJ45 connectors.

The ODT 1510 also supports mixing and matching of serial standards. For example: the transmitting module can have a RS232 input, and the receiving module can be set for RS422 output.

Fiber Adapter Options (singlemode only not multimode)

These adapter kits allow the use of ST or SC fiber connections on the module. SMF 0.5m (19.6") tail introduces less than 0.25dB attenuation.

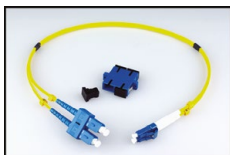

Model# **LC/SC DUP**
LC/PC to SC/PC Adapter

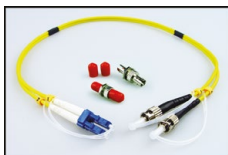

Model# **LC/ST DUP**
LC/PC to ST/SC Adapter



Technical Specifications

Serial I/O	EIA/ETA RS232C / RS422 / RS485 (selectable)
	Connector - RJ45
	Baud rate - Auto sense and auto adjust from 300 to 460k
	Serial setting dip switch provides settings for: <ul style="list-style-type: none"> • Select RS232 / RS422 / RS485 modes • Select serial termination (for end of line) • RX/TX crossover to flip the RX and TX if needed • Set RS422/485 data direction to automatic or manual if needed
	LED status indicators (under RJ45 connector) Serial TX activity + Serial RX activity
	RS422/485 Max number of electrical nodes = 25
	ESD protection for up to 26kV
GPI I/O	2x general purpose inputs + 2x general purpose outputs
	Connector RJ45
	GPI Inputs: <ul style="list-style-type: none"> • External passive closure between pins (short) to trigger • Max input switching frequency 25Hz (50 operations / second) • Input insulation 3.75kV
	GPI Outputs: <ul style="list-style-type: none"> • Internal contact closure (relay) • Max switching frequency 25Hz (50 operations / second) • Max switching power 220VDC / 0.25A or 250VAC / 0.25A • Output insulation 3.75kV
	LED status indicators (under RJ45 connector) GPI Input 1 activity / GPI Input 2 activity GPI Output 1 activity / GPI Output 2 activity
Fiber Optic	1 x Fiber output (TX) and 1 x Fiber input (RX) Singlemode fiber or Multimode fiber. LC/PC connections
	Singlemode Version: ODT 1510 TX wavelength 1310nm, power -3dBm RX input range 1260nm to 1620nm, sensitivity -3dBm to -21dBm Max. Distance 10km (6.2 miles)
	Multimode Version: ODT 1510 MM TX wavelength 850nm, power -2dBm to -7dBm RX input 850m, sensitivity 0dBm to -15dBm Max. Distance 550m (1804 feet)
	RX and TX activity LEDs on side of module next to fiber I/O
Power	+12VDC @ 2.0W nominal - (supports 7 - 15VDC input range)
Physical	Size: 120mm x 42mm x 22mm (4.73" x 1.65" x 0.86") including connectors Weight: 125g (4.4oz)
Ambient	5 - 40°C (41 - 104°F) 90% Humidity (non condensing)
Model #	ODT 1510 (Singlemode) - (EAN# 4250479315136) ODT 1510 MM (Multimode) - (EAN# 4250479321137)
Includes	Module, AC power supply

Specifications subject to change

Connection Diagrams

RS 232 Connections

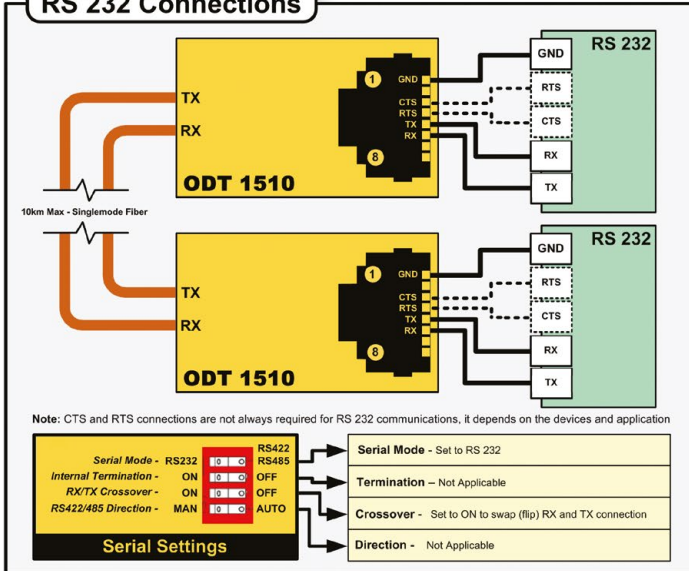

RS 422/485 Connections

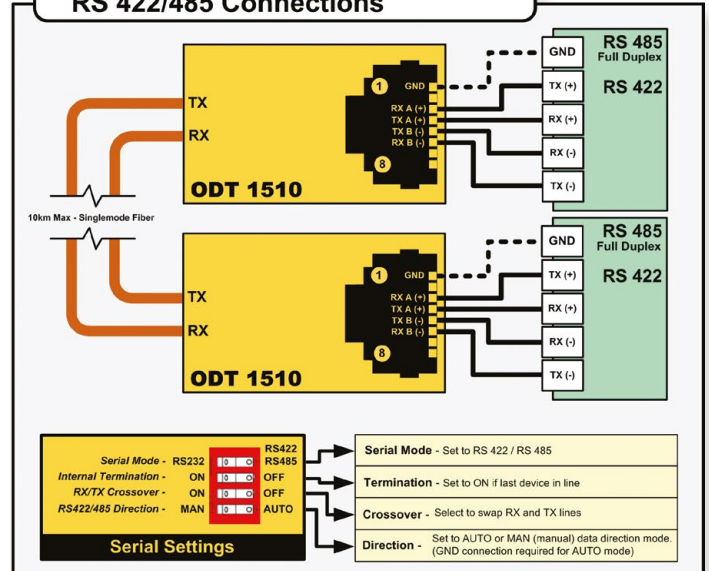

GPI Connections

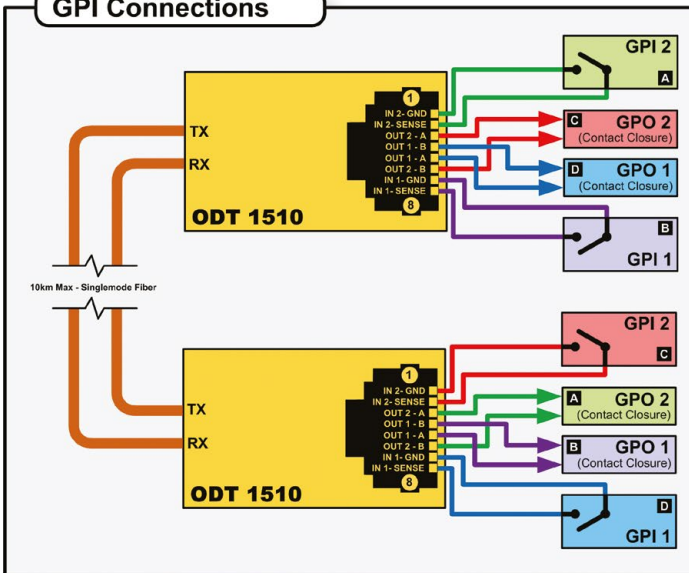

RS 485 Connections – Half Duplex

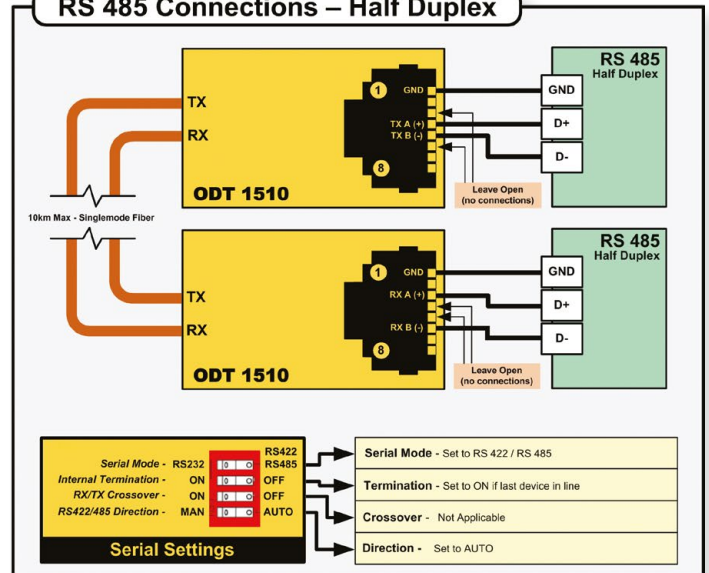

Power Adapter Options

The kit **INCLUDES** AC power supplies. The power adapters below are optional.



P-TAP 1000
Use with a standard battery P-TAP power source.



XLR 1000
Use with a standard 4 pin XLR camera battery power source.

Specifications subject to change